

## Smart Signage User Manual (By Model)

This manual provides information about your Smart Signage including supported types and product specifications per model.

---

QBR (QB43R QB49R QB50R QB55R QB65R QB75R QB85R QB98R)  
QBR-B (QB43R-B QB49R-B QB50R-B QB55R-B QB65R-B QB75R-B QB85R-B)  
QER (QE82R)  
QMR (QM32R QM43R QM49R QM50R QM55R QM65R QM75R QM85R)  
QMR-A (QM32R-A QM43R-A QM50R-A QM55R-A QM65R-A QM75R-A)  
QMR-AN (QM32R-AN)  
QMR-B (QM32R-B QM43R-B QM50R-B QM55R-B QM65R-B QM75R-B QM85R-B)  
QMR-T (QM32R-T QM43R-T QM55R-T)

---

The colour and the appearance may differ depending on the product, and the content in the manual is subject to change without prior notice to improve the performance.

Recommended hours of use per day for the QBR models (except for QB98R), QM32R-T, and QER models is less than 16 hours.

If the product is used for longer than 16 hours a day, the warranty may be void.

An administration fee may be charged in the following situations:

- (a) An engineer is called out at your request, but it is found that the product has no defect (i.e., where the user manual has not been read).
- (b) You bring the unit to a repair centre, but it is found that the product has no defect (i.e., where the user manual has not been read).

You will be informed of the administration fee amount before a technician visits.

---

# Table of contents

## Preparations

---

Checking the Components	3
-------------------------	---

---

<b>Parts</b>	<b>4</b>
Q*32R*/Q*43R*/Q*49R*/Q*50R*/Q*55R*/ Q*65R*/Q*75R*/Q*82R*/Q*85R*	4
QB98R	5
Anti-theft Lock	6

---

<b>Ports</b>	<b>7</b>
Q*43R*/Q*49R*/Q*50R*/Q*55R*/Q*65R*/ Q*75R*/Q*82R*/Q*85R*	7
QM43R-A/QM50R-A/QM55R-A/QM65R-A/ QM75R-A/QM43R-B/QM50R-B/QM55R-B/ QM65R-B/QM75R-B	8
QM32R	9
QM32R-A/QM32R-AN/QM32R-B	10
QB98R	11
QM32R-T	12
QM43R-T/QM55R-T	13

---

<b>Control menu</b>	<b>14</b>
---------------------	-----------

---

<b>Administrator menu (Supported models: QMR-T)</b>	<b>15</b>
---	-----------

---

<b>Precautions when handling the panel</b>	<b>16</b>
--	-----------

---

<b>Before Installing the Product (Installation Guide)</b>	<b>17</b>
Tilting Angle and Rotation	17
Ventilation	17

---

<b>Installing the Wall Mount</b>	<b>18</b>
Preparing before installing Wall-Mount	18
Installing the Wall Mount	18
Wall Mount Kit Specifications (VESA)	19

## Using a touchscreen monitor (Supported models: QMR-T)

---

<b>Touchscreen monitor</b>	<b>20</b>
Read below before using the product	20

---

<b>Connecting the touch overlay</b>	<b>20</b>
-------------------------------------	-----------

---

<b>Connecting the touchscreen monitor</b>	<b>21</b>
Connecting to a PC	21
Connecting to a laptop or tablet PC	21

---

<b>Configuring the touchscreen monitor settings</b>	<b>22</b>
Calibration	22

## Specifications

---

<b>General</b>	<b>24</b>
----------------	-----------

---

<b>Preset Timing Modes</b>	<b>27</b>
----------------------------	-----------

## Appendix

---

<b>Licence</b>	<b>28</b>
----------------	-----------

# Chapter 01

## Preparations

### Checking the Components

- Contact the vendor where you purchased the product if any components are missing.
- The appearance of the components may differ from the images shown.
- A stand is not provided with the product. To install a stand, you can purchase one separately.
- The RS232C adapter can be used to connect to another monitor using the D-SUB (9-pin) type RS232C cable.
- \* : A ~ Z

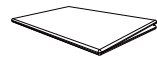

Quick Setup Guide



Warranty card  
(Not available in some locations)



Regulatory guide



Power cord

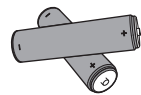

Batteries (AAA x 2)  
(Not available in some locations)



Remote Control

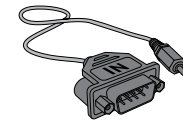

RS232C adapter



HOLDER-CABLE  
(Supported models: Q\*65R\*,  
Q\*75R\*, Q\*82R\*, Q\*85R\*,  
Q\*98R\*)

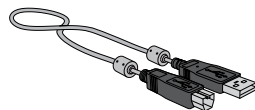

TOUCH OUT cable x 2  
(Supported models: QMR-T)

## Parts

Q\*32R\*/Q\*43R\*/Q\*49R\*/Q\*50R\*/  
Q\*55R\*/Q\*65R\*/Q\*75R\*/Q\*82R\*/  
Q\*85R\*

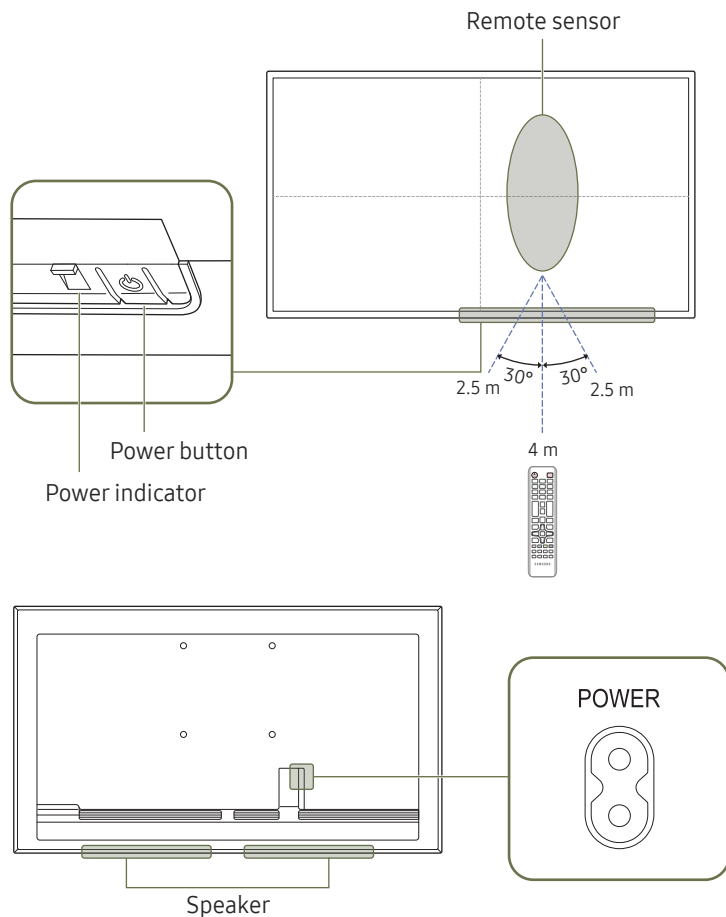

The colour and shape of parts may differ from what is shown. Specifications are subject to change without notice to improve quality.

Parts	Description
Remote sensor	Press a button on the remote control pointing at the sensor on the front of the product to perform the corresponding function. Using other display devices in the same space as the remote control of this product can cause the other display devices to be inadvertently controlled.
Power button	Turns the product on or off.

Use the remote control within 2.5 m to 4 m from the sensor on the product at an angle of 30° from the left and right.

To enhance the IR receiver performance, connect an external IR cable (sold separately) to the IR IN port.

\*: A ~ Z

# QB98R

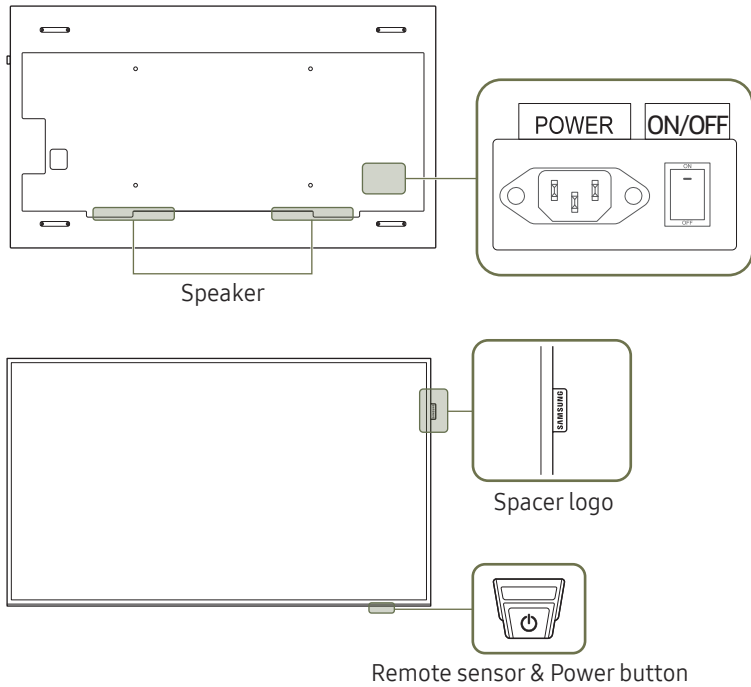

The colour and shape of parts may differ from what is shown. Specifications are subject to change without notice to improve quality.





Parts	Description	
Spacer logo	Do not pull on the spacer logo using force. The logo may tear or break off.	
Remote sensor	Press a button on the remote control pointing at the bottom of the product face to perform the function. The remote control sensor is located on the bottom of the product. Using other display devices in the same space as the remote control of this product can cause the other display devices to be inadvertently controlled.	
		To use remote/eco sensor, make sure the sliding power button is protruding from the bottom of the product.
Power button		
		To use the power button, make sure the sliding power button is not protruding from the bottom of the product.

Use the remote control within 7 m to 10 m from the sensor on the product at an angle of 30° from the left and right.

To enhance the IR receiver performance, connect an external IR cable (sold separately) to the IR IN port.

---

## Anti-theft Lock

-  An anti-theft lock allows you to use the product securely even in public places.
-  The locking device shape and locking method depend on the manufacturer. Refer to the user guide provided with your anti-theft locking device for details.
-  The following images are for reference only. Real-life situations may differ from what is shown in the images.
-  Supported model: QB98R

### To lock an anti-theft locking device:

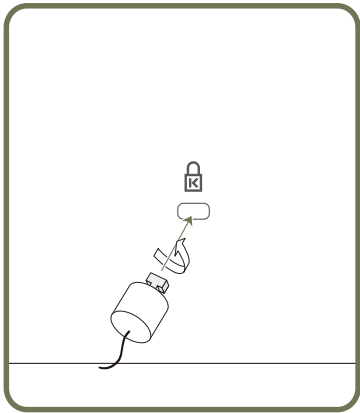

- 1 Fix the cable of your anti-theft locking device to a heavy object such as a desk.
- 2 Put one end of the cable through the loop on the other end.
- 3 Insert the locking device into the anti-theft lock slot at the back of the product.
- 4 Lock the locking device.
  - An anti-theft locking device can be purchased separately.
  - Refer to the user guide provided with your anti-theft locking device for details.
  - Anti-theft locking devices can be purchased at electronics retailers or online.

# Ports





## Q\*43R\*/Q\*49R\*/Q\*50R\*/Q\*55R\*/ Q\*65R\*/Q\*75R\*/Q\*82R\*/Q\*85R\*

 The colour and shape of parts may differ from what is shown.  
Specifications are subject to change without notice to improve quality.

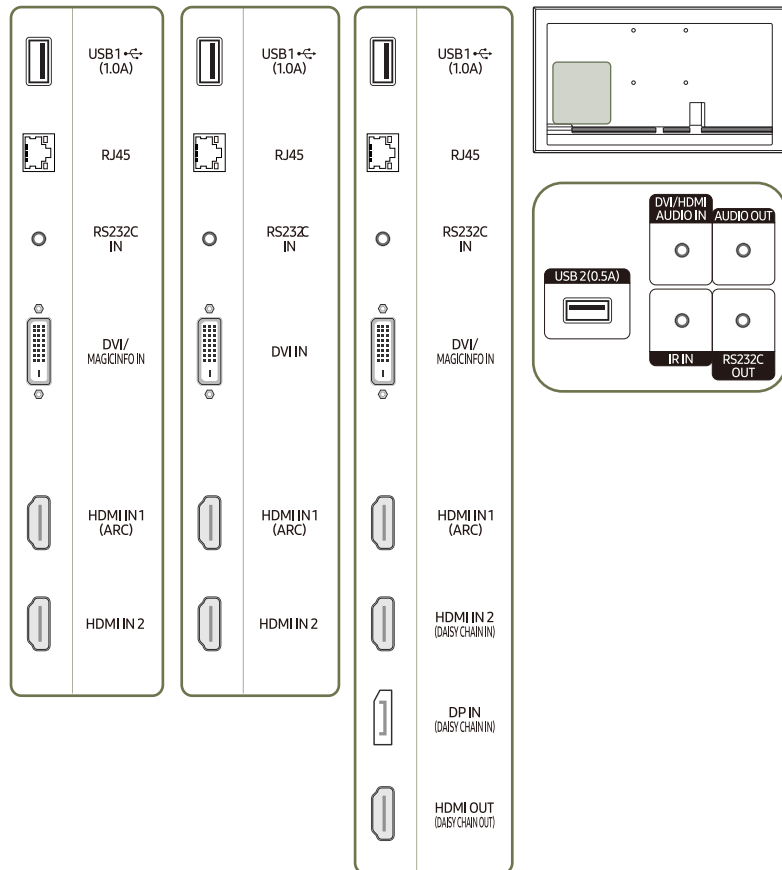
QB43R / QB43R-B / QB49R /  
QB49R-B / QB50R / QB50R-B /  
QB55R / QB55R-B / QB65R /  
QB65R-B / QB75R / QB75R-B /  
QB85R / QB85R-B

QM43R / QM49R / QM50R /  
QM55R / QM65R / QM75R /  
QM85R / QM85R-B







Port	Description
USB1  (1.0A)	Connect to a USB memory device.  The USB ports on the product accept a maximum constant current of 1.0A. If the maximum value is exceeded, USB ports may not work.
RJ45	Connects to MDC and the Internet using a LAN cable. (10/100 Mbps)  Use Cat7(*STP Type) cable for the connection. *Shielded Twist Pair.
RS232C IN	Connects to MDC using an RS232C adapter.
DVI/MAGICINFO IN	DVI IN: Connects to a source device using a DVI cable or HDMI-DVI cable.
DVI IN	MAGICINFO IN: Connects to a network box using DP-DVI cable to use Magicinfo.
HDMI IN 1 (ARC)	Connects to a source device using a HDMI cable or HDMI-DVI cable.
HDMI IN 2	
HDMI IN 2 (DAISY CHAIN IN)	<ul style="list-style-type: none"> <li>Connects to a source device using a HDMI cable or HDMI-DVI cable.</li> <li>Connects to another product using a HDMI cable.</li> </ul>
DP IN (DAISY CHAIN IN)	Connects to a PC using a DP cable.
HDMI OUT (DAISY CHAIN OUT)	Connects to another product using a HDMI cable.
USB 2(0.5A)	Connect to a USB memory device.  The USB ports on the product accept a maximum constant current of 0.5A. If the maximum value is exceeded, USB ports may not work.
DVI/HDMI AUDIO IN	Receives sound from a source device via an audio cable.
AUDIO OUT	Outputs sound to an audio device via an audio cable.
IR IN	Connects to an external IR cable that receives signals from the remote control.
RS232C OUT	Connects to MDC using an RS232C adapter.

 \*: A ~ Z

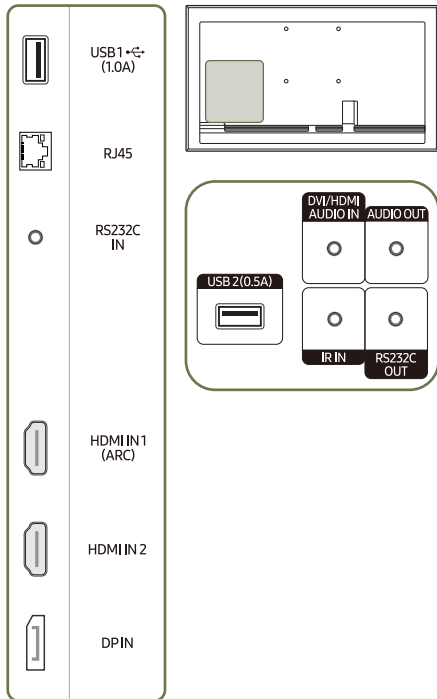
# QM43R-A/QM50R-A/QM55R-A/ QM65R-A/QM75R-A/QM43R-B/ QM50R-B/QM55R-B/QM65R-B/QM75R-B

 The colour and shape of parts may differ from what is shown.  
Specifications are subject to change without notice to improve quality.







Port	Description
USB1  (1.0A)	Connect to a USB memory device.  The USB ports on the product accept a maximum constant current of 1.0A. If the maximum value is exceeded, USB ports may not work.
RJ45	Connects to MDC and the Internet using a LAN cable. (10/100 Mbps)  Use Cat7(*STP Type) cable for the connection. *Shielded Twist Pair.
RS232C IN	Connects to MDC using an RS232C adapter.
HDMI IN 1 (ARC)	Connects to a source device using a HDMI cable or HDMI-DVI cable.
HDMI IN 2	
DP IN	Connects to a PC using a DP cable.
USB 2(0.5A)	Connect to a USB memory device.  The USB ports on the product accept a maximum constant current of 0.5A. If the maximum value is exceeded, USB ports may not work.
DVI/HDMI AUDIO IN	Receives sound from a source device via an audio cable.
AUDIO OUT	Outputs sound to an audio device via an audio cable.
IR IN	Connects to an external IR cable that receives signals from the remote control.
RS232C OUT	Connects to MDC using an RS232C adapter.

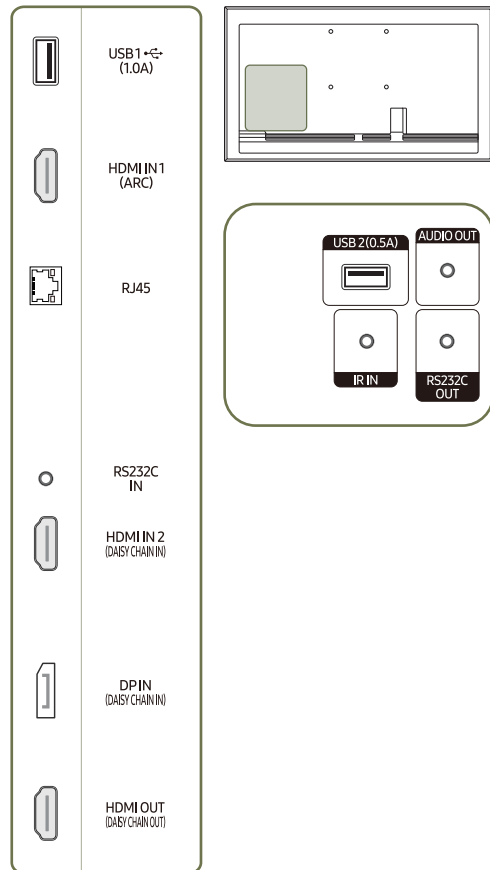

# QM32R

 The colour and shape of parts may differ from what is shown. Specifications are subject to change without notice to improve quality.





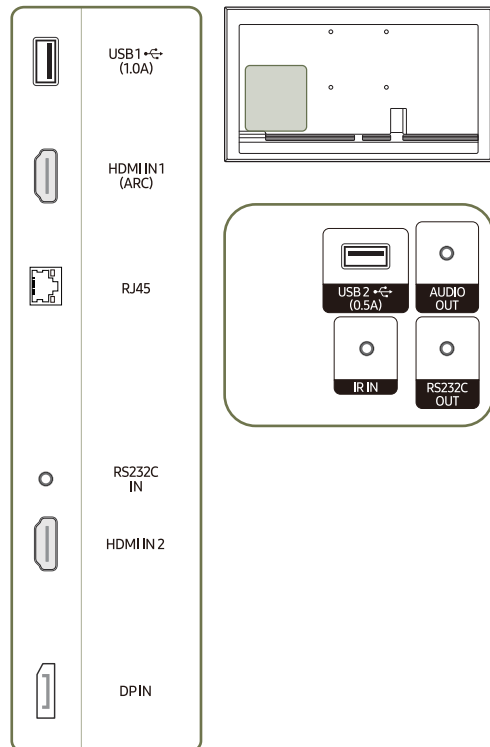

Port	Description
USB 1  (1.0A)	Connect to a USB memory device.  The USB ports on the product accept a maximum constant current of 1.0A. If the maximum value is exceeded, USB ports may not work.
HDMI IN 1 (ARC)	Connects to a source device using a HDMI cable or HDMI-DVI cable.
RJ45	Connects to MDC and the Internet using a LAN cable. (10/100 Mbps)  Use Cat7(*STP Type) cable for the connection. *Shielded Twist Pair.
RS232C IN	Connects to MDC using an RS232C adapter.
HDMI IN 2 (DAISY CHAIN IN)	<ul style="list-style-type: none"> <li>Connects to a source device using a HDMI cable or HDMI-DVI cable.</li> <li>Connects to another product using a HDMI cable.</li> </ul>
DP IN (DAISY CHAIN IN)	Connects to a PC using a DP cable.
HDMI OUT (DAISY CHAIN OUT)	Connects to another product using a HDMI cable.
USB 2(0.5A)	Connect to a USB memory device.  The USB ports on the product accept a maximum constant current of 0.5A. If the maximum value is exceeded, USB ports may not work.
AUDIO OUT	Outputs sound to an audio device via an audio cable.
IR IN	Connects to an external IR cable that receives signals from the remote control.
RS232C OUT	Connects to MDC using an RS232C adapter.

## QM32R-A/QM32R-AN/QM32R-B

 The colour and shape of parts may differ from what is shown.  
Specifications are subject to change without notice to improve quality.





Port	Description
USB1  (1.0A)	Connect to a USB memory device.  The USB ports on the product accept a maximum constant current of 1.0A. If the maximum value is exceeded, USB ports may not work.
HDMI IN 1 (ARC)	Connects to a source device using a HDMI cable or HDMI-DVI cable.
RJ45	Connects to MDC and the Internet using a LAN cable. (10/100 Mbps)  Use Cat7(*STP Type) cable for the connection. *Shielded Twist Pair.
RS232C IN	Connects to MDC using an RS232C adapter.
HDMI IN 2	Connects to a source device using a HDMI cable or HDMI-DVI cable.
DP IN	Connects to a PC using a DP cable.
USB 2  (0.5A)	Connect to a USB memory device.  The USB ports on the product accept a maximum constant current of 0.5A. If the maximum value is exceeded, USB ports may not work.
AUDIO OUT	Outputs sound to an audio device via an audio cable.
IR IN	Connects to an external IR cable that receives signals from the remote control.
RS232C OUT	Connects to MDC using an RS232C adapter.

# QB98R

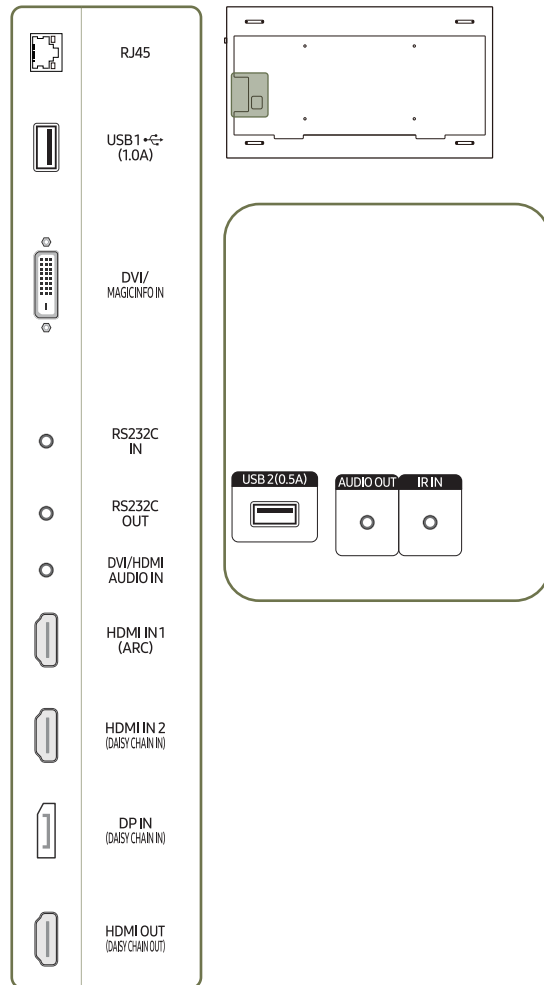
 The colour and shape of parts may differ from what is shown. Specifications are subject to change without notice to improve quality.





Port	Description
RJ45	Connects to MDC and the Internet using a LAN cable. (10/100 Mbps)  Use Cat7(*STP Type) cable for the connection. *Shielded Twist Pair.
USB1 (1.0A)	Connect to a USB memory device.  The USB ports on the product accept a maximum constant current of 1.0A. If the maximum value is exceeded, USB ports may not work.
DVI/MAGICINFO IN	DVI IN: Connects to a source device using a DVI cable or HDMI-DVI cable. MAGICINFO IN: Connects to a network box using DP-DVI cable to use Magicinfo.
RS232C IN	Connects to MDC using an RS232C adapter.
RS232C OUT	Connects to MDC using an RS232C adapter.
DVI/HDMI AUDIO IN	Receives sound from a source device via an audio cable.
HDMI IN 1 (ARC)	Connects to a source device using a HDMI cable or HDMI-DVI cable.
HDMI IN 2 (DAISY CHAIN IN)	<ul style="list-style-type: none"> <li>Connects to a source device using a HDMI cable or HDMI-DVI cable.</li> <li>Connects to another product using a HDMI cable.</li> </ul>
DP IN (DAISY CHAIN IN)	Connects to a PC using a DP cable.
HDMI OUT (DAISY CHAIN OUT)	Connects to another product using a HDMI cable.
USB 2(0.5A)	Connect to a USB memory device.  The USB ports on the product accept a maximum constant current of 0.5A. If the maximum value is exceeded, USB ports may not work.
AUDIO OUT	Outputs sound to an audio device via an audio cable.
IR IN	Connects to an external IR cable that receives signals from the remote control.

# QM32R-T

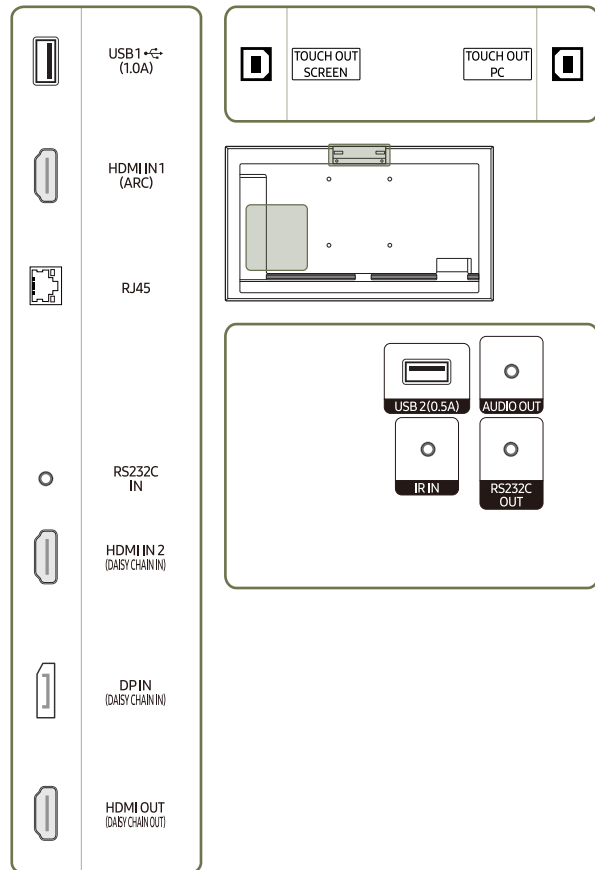
 The colour and shape of parts may differ from what is shown. Specifications are subject to change without notice to improve quality.





Port	Description
USB 1 (1.0A)	Connect to a USB memory device or TOUCH OUT cable.  The USB ports on the product accept a maximum constant current of 1.0A. If the maximum value is exceeded, USB ports may not work.
HDMI IN 1 (ARC)	Connects to a source device using a HDMI cable or HDMI-DVI cable.
RJ45	Connects to MDC and the Internet using a LAN cable. (10/100 Mbps)  Use Cat7(*STP Type) cable for the connection. *Shielded Twist Pair.
RS232C IN	Connects to MDC using an RS232C adapter.
HDMI IN 2 (DAISY CHAIN IN)	<ul style="list-style-type: none"> <li>Connects to a source device using a HDMI cable or HDMI-DVI cable.</li> <li>Connects to another product using a HDMI cable.</li> </ul>
DP IN (DAISY CHAIN IN)	Connects to a PC using a DP cable.
HDMI OUT (DAISY CHAIN OUT)	Connects to another product using a HDMI cable.
USB 2 (0.5A)	Connect to a USB memory device or TOUCH OUT cable.  The USB ports on the product accept a maximum constant current of 0.5A. If the maximum value is exceeded, USB ports may not work.
AUDIO OUT	Outputs sound to an audio device via an audio cable.
IR IN	Connects to an external IR cable that receives signals from the remote control.
RS232C OUT	Connects to MDC using an RS232C adapter.
TOUCH OUT SCREEN	Connect to a USB port on the product to use the touch function.
TOUCH OUT PC	Connect to a USB port on a PC to use the touch function.

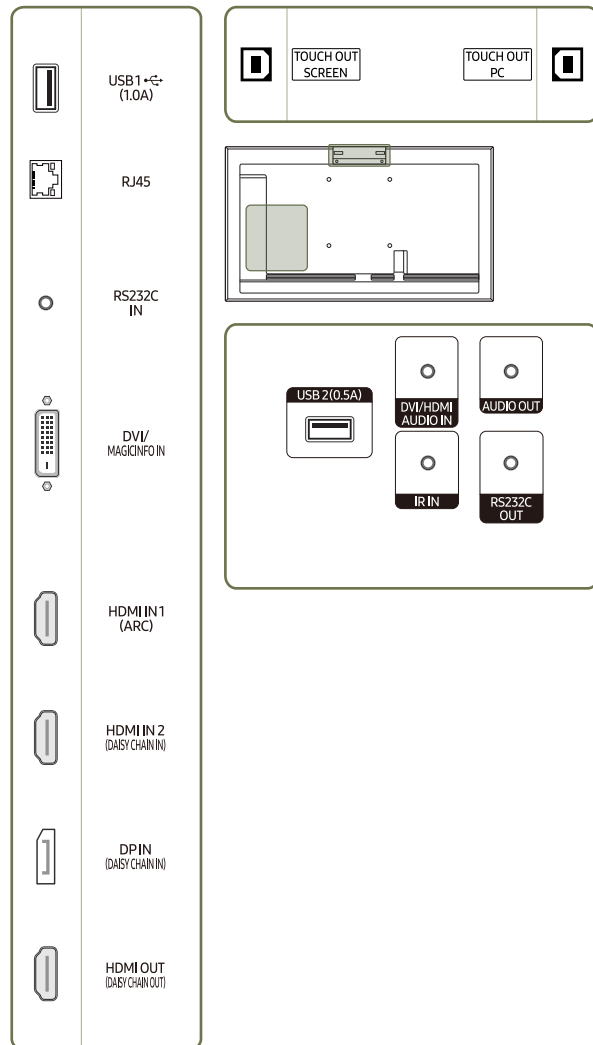

## QM43R-T/QM55R-T

 The colour and shape of parts may differ from what is shown.  
Specifications are subject to change without notice to improve quality.





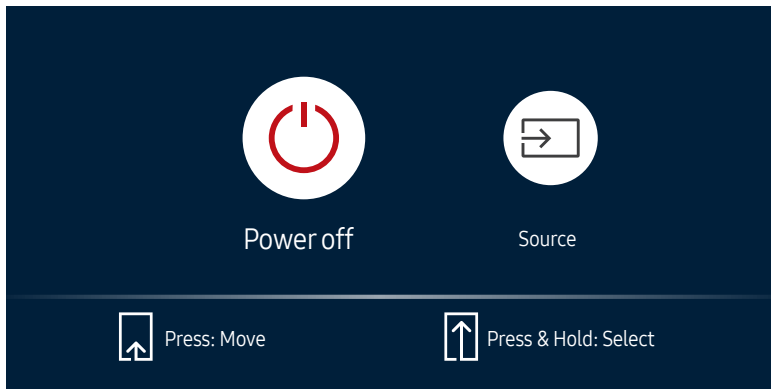

Port	Description
USB 1 (1.0A)	Connect to a USB memory device or TOUCH OUT cable.  The USB ports on the product accept a maximum constant current of 1.0A. If the maximum value is exceeded, USB ports may not work.
RJ45	Connects to MDC and the Internet using a LAN cable. (10/100 Mbps)  Use Cat7(*STP Type) cable for the connection. *Shielded Twist Pair.
RS232C IN	Connects to MDC using an RS232C adapter.
DVI/MAGICINFO IN	DVI IN: Connects to a source device using a DVI cable or HDMI-DVI cable. MAGICINFO IN: Connects to a network box using DP-DVI cable to use Magicinfo.
HDMI IN 1 (ARC)	Connects to a source device using a HDMI cable or HDMI-DVI cable.
HDMI IN 2 (DAISY CHAIN IN)	<ul style="list-style-type: none"> <li>Connects to a source device using a HDMI cable or HDMI-DVI cable.</li> <li>Connects to another product using a HDMI cable.</li> </ul>
DP IN (DAISY CHAIN IN)	Connects to a PC using a DP cable.
HDMI OUT (DAISY CHAIN OUT)	Connects to another product using a HDMI cable.
USB 2 (0.5A)	Connect to a USB memory device or TOUCH OUT cable.  The USB ports on the product accept a maximum constant current of 0.5A. If the maximum value is exceeded, USB ports may not work.
DVI/HDMI AUDIO IN	Receives sound from a source device via an audio cable.
AUDIO OUT	Outputs sound to an audio device via an audio cable.
IR IN	Connects to an external IR cable that receives signals from the remote control.
RS232C OUT	Connects to MDC using an RS232C adapter.
TOUCH OUT SCREEN	Connect to a USB port on the product to use the touch function.
TOUCH OUT PC	Connect to a USB port on a PC to use the touch function.

## Control menu

-  The power button(⏻) is located on the bottom of the product.
-  If you press the power button on the product when the product is turned on, the control menu will be displayed.











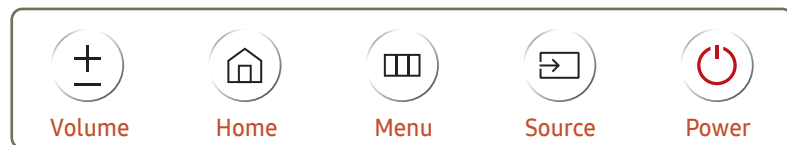
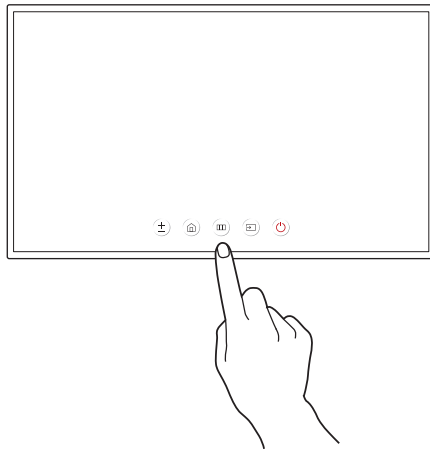

Items	Description
 <b>Power off</b>	<p>Power off the product.</p> <ul style="list-style-type: none"><li>With the control menu screen displayed, briefly press the power button to move the cursor to  <b>Power off</b>, and then press and hold the power button to turn off the product.</li></ul>
 <b>Source</b>	<p>Select the connected input source.</p> <ul style="list-style-type: none"><li>With the control menu screen displayed, briefly press the power button to move the cursor to  <b>Source</b>, and then press and hold the power button to display the input source screen.</li><li>With the input source screen displayed, press and hold the power button to switch to the desired input source.</li></ul>

-  The power button can only be used for **Power off** and **Source**.
-  To exit from the control menu screen, wait for 3 seconds or more without pressing the power button.

## Administrator menu (Supported models: QMR-T)

- Touching and holding on the screen when the product is turned on displays the administrator menu.
- If the touchscreen control is not available, use the remote control to go to **System** → **Touch Control** → **Touch Control** and select **On** from the OSD menu.
- If the administrator menu is not displayed, use the remote control to go to **System** → **Touch Control** → **Admin Menu Lock** and select **Off** from the OSD menu.
- This menu is not displayed, when using touch mode on a connected PC.



Buttons	Description
 <b>Volume</b>	Adjust the <b>Volume</b> . <ul style="list-style-type: none"><li>Select  <b>Volume</b> from the administrator menu.</li></ul>
 <b>Home</b>	Enter <b>Home</b> screen. <ul style="list-style-type: none"><li>Select  <b>Home</b> from the administrator menu.</li></ul>
 <b>Menu</b>	Display the OSD menu. To change settings, select a menu item. <ul style="list-style-type: none"><li>Select  <b>Menu</b> from the administrator menu.</li></ul>
 <b>Source</b>	Select the connected input source. Select an input source from the displayed list of input sources. <ul style="list-style-type: none"><li>Select  <b>Source</b> from the administrator menu.</li></ul>
 <b>Power</b>	Power off the product. <ul style="list-style-type: none"><li>Select  <b>Power</b> from the administrator menu.</li></ul>

## Precautions when handling the panel

 The colour and the appearance may differ depending on the model.

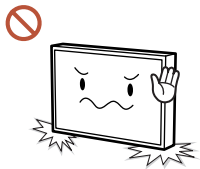

Do not stand the product as shown in the image. The panel is fragile and can get damaged.

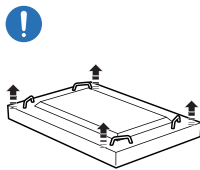

Lay the product down to handle it as shown in the image. (the packaging can be used).

 Supported models: 85 inches or more

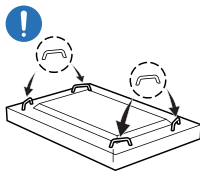

Ensure you use the handles on the back when moving the product.

 Supported models: 85 inches or more

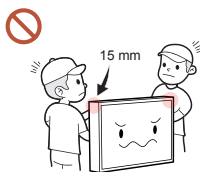

Do not hold or grasp any area of the product within 15 mm from the front.



## Before Installing the Product (Installation Guide)

To prevent injury, this apparatus must be securely attached to the floor/wall in accordance with the installation instructions.

- Ensure that an authorised installation company installs the wall mount.
- Otherwise, it may fall and cause personal injury.
- Make sure to install the specified wall mount.

## Tilting Angle and Rotation

Contact Samsung Customer Service Centre for further details.

- The product can be tilted at a maximum angle of 15° from a perpendicular wall surface.
- To use the product in Portrait mode, rotate clockwise until the power indicator (A or B) is positioned as shown in the images below.

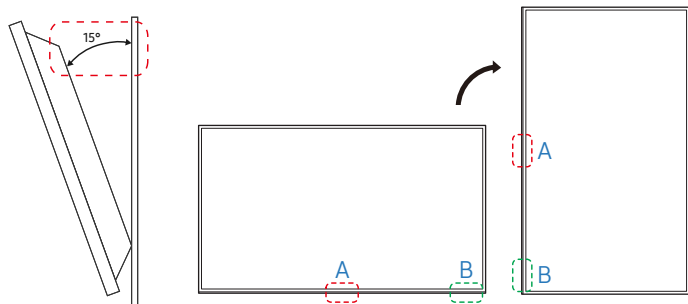

Do not use this model installed on a ceiling, floor, or table.

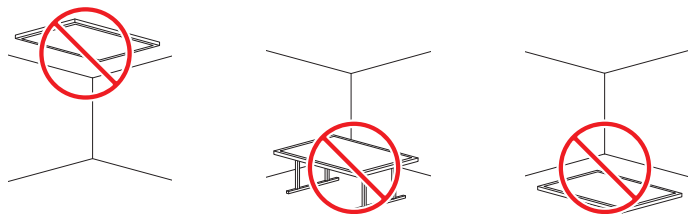

## Ventilation

Contact Samsung Customer Service Centre for further details.

### Installation on a Perpendicular Wall

A Minimum 40 mm

B Ambient temperature: Under 35 °C

When installing the product on a perpendicular wall, allow at least 40 mm of space between the product and wall surface for ventilation and ensure that the ambient temperature is kept below 35 °C.

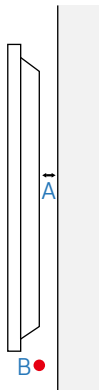

### Installation on an Indented Wall

A Minimum 40 mm

B Minimum 70 mm

C Minimum 50 mm

D Minimum 50 mm

E Ambient temperature: Under 35 °C

When installing the product on an indented wall, allow at least the space specified above between the product and wall for ventilation and ensure that the ambient temperature is kept below 35 °C.

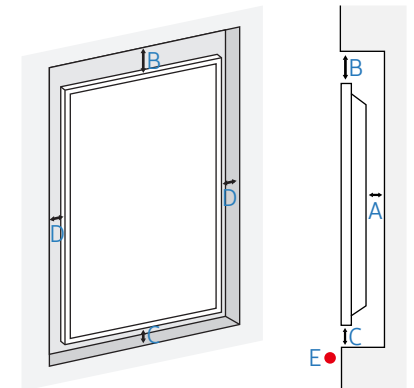

---

## Installing the Wall Mount

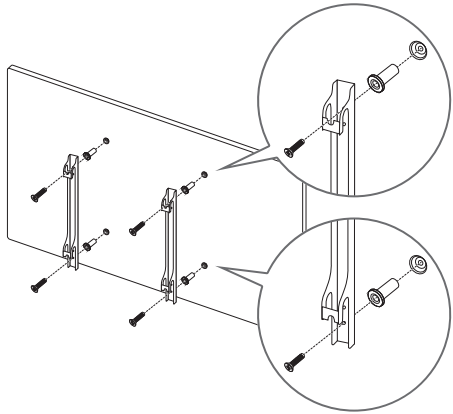

### Preparing before installing Wall-Mount

To install a wall-mount from another manufacturer, use the Holder-Ring.

### Installing the Wall Mount

- The wall mount kit (sold separately) allows you to mount the product on the wall.
- The provided image is only for reference. For detailed information on installing the wall mount, see instructions provided with the wall mount.
- We recommend you contact a technician for assistance when installing the wall mount bracket.
- Samsung is not responsible for any damage to the product or injury to yourself or others if you select to install the wall mount on your own.

## Wall Mount Kit Specifications (VESA)

 Install your wall mount on a solid wall perpendicular to the floor. To install the product on the other wall area, contact the nearest agency. If you install the product on a slanted wall, it may fall and result in severe personal injury.

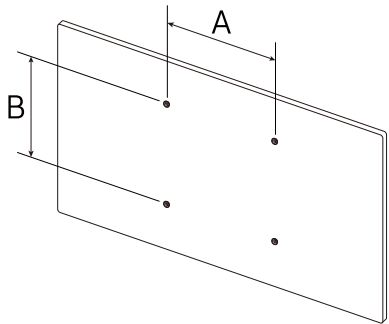

- Samsung wall mount kits contain a detailed installation manual and all parts necessary for assembly are provided.
- Do not use screws that are longer than the standard length or do not comply with the VESA standard screw specifications. Screws that are too long may cause damage to the inside of the product.
- For wall mounts that do not comply with the VESA standard screw specifications, the length of the screws may differ depending on the wall mount specifications.
- Do not fasten the screws too firmly. This may damage the product or cause the product to fall, leading to personal injury. Samsung is not liable for these kinds of accidents.
- Samsung is not liable for product damage or personal injury when a non-VESA or non-specified wall mount is used or the consumer fails to follow the product installation instructions.
- Do not mount the product at more than a 15 degree tilt.
- Always have at least two people mount the product on a wall. (Four or more people for the 82-inch size and larger models.)
- Standard dimensions for wall mount kits are shown in the table below.

Model Name	VESA screw hole specs (A * B) in millimetres	Standard Screw	Quantity
Q*32R* / Q*43R* / Q*49R* / Q*50R* / Q*55R*	200 × 200	M8	4
Q*65R* / Q*75R*	400 × 400		
Q*82R* / Q*85R*	600 × 400		
Q*98R*	900 × 600		

 Do not install your Wall Mount Kit while your product is turned on. It may result in personal injury due to electric shock.

 \*: A ~ Z

# Chapter 02

## Using a touchscreen monitor (Supported models: QMR-T)

### Touchscreen monitor

Control a PC by tapping the screen instead of using an input device such as a keyboard or mouse. The touch screen functions by detecting a minute electric current that runs through your body (capacitive). Make sure to use the surface of your finger tip when tapping the screen.

### Read below before using the product

- Take extra care to ensure an electrical substance does not contact the screen. The screen may not function properly if there is static.
- Do not press hard on the touchscreen with your finger tip. Do not use a sharp object when tapping the screen. The screen may break or get damaged.
- Do not tap the screen while wearing a glove, with a dirty finger, or using something sharp such as your fingernail or a ballpoint pen. The screen may not function properly.
- Take extra care to ensure the screen does not contact moisture. The touch sensor may not function properly.
- Displaying a still image on the screen for an extended period of time may cause after images (screen degradation) or stains. Switch off the screen when not in use.

### Connecting the touch overlay

 Touch functions are not supported in applications other than the OSD menu and administrator menu.

Connect the TOUCH OUT cable between TOUCH OUT SCREEN and USB 1 (1.0A) or USB 2 (0.5A) port on the product.

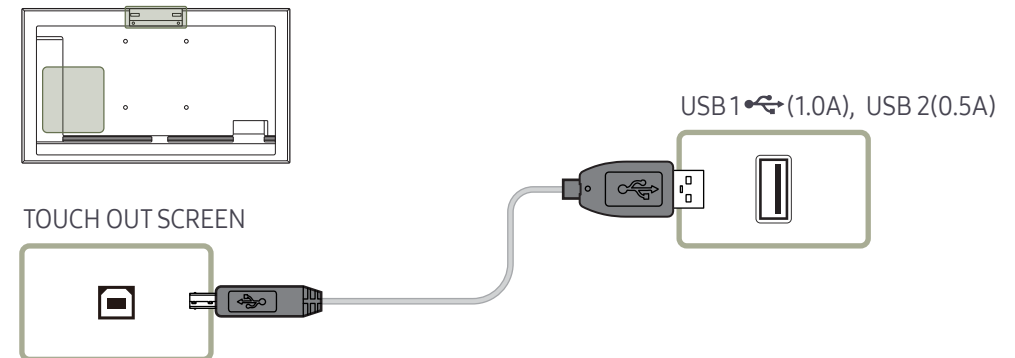

## Connecting the touchscreen monitor

 Connecting parts may differ in different products.

### Connecting to a PC

- 1 Connect your PC to the product using a HDMI or HDMI-DVI cable.

#### Connecting the devices using a HDMI cable

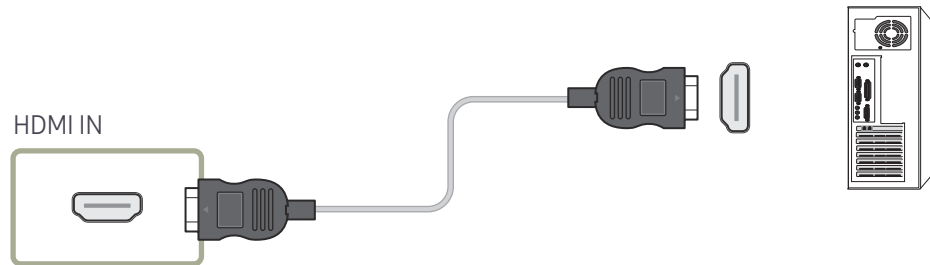

#### Connecting the devices using a HDMI-DVI cable

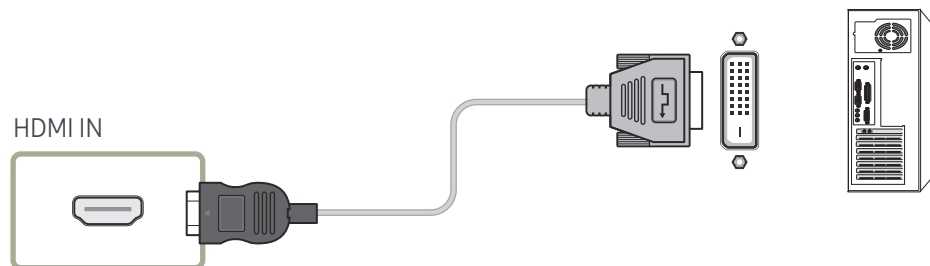

- 2 Connect the power cable from the product to the power outlet.
- 3 After the power supply is connected, the product automatically detects and switches to the connected input source.
  -  If the screen appears blank, turn the product off and then on again.
- 4 Connect the TOUCH OUT PC port on the product to a USB port on the PC using the TOUCH OUT cable.

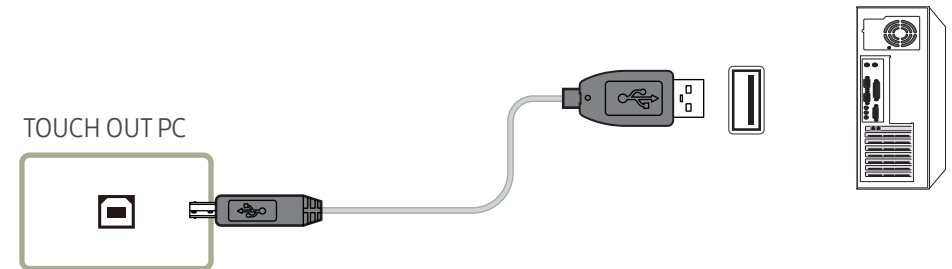

### Connecting to a laptop or tablet PC

A laptop or tablet PC can be connected to the product using the same method when connecting a desktop PC.

-  If touchscreen control is not available after the devices are connected
  - Make sure to connect the HDMI or HDMI-DVI cable before connecting the TOUCH OUT cable.
  - If touchscreen control is still unavailable after the cables are connected properly, disconnect the TOUCH OUT cable and then connect it again.

# Configuring the touchscreen monitor settings

To properly use the touch function of the product in Windows, go to **Tablet PC Settings** and calibrate the product.

- ✎ First connect the touchscreen monitor before configuring the following settings.
- ✎ The maximum number of touchscreen monitors that can be connected simultaneously varies, depending on the operating system and graphics card settings.
- ✎ If **Tablet PC Settings** is not found in **Control Panel**, search for **Tablet PC Settings** from **Search Control Panel**.
- ✎ If used in a multi-screen setup, make sure you have configured QMR-T as the main display.

## Calibration

- ✎ Instructions below are for Windows 8. The same method applies to both Windows 7, Windows 8 and Windows 10.
- ✎ After changing the **Picture Size** from the OSD menu, you may need to calibrate the picture settings again.
- ✎ Upon occurrence of an error during calibration, go to **Tablet PC Settings**. In the **Display** tab, tap **Reset** and calibrate again.

1 In the **Display** tab, select **Setup** under **Configure**.

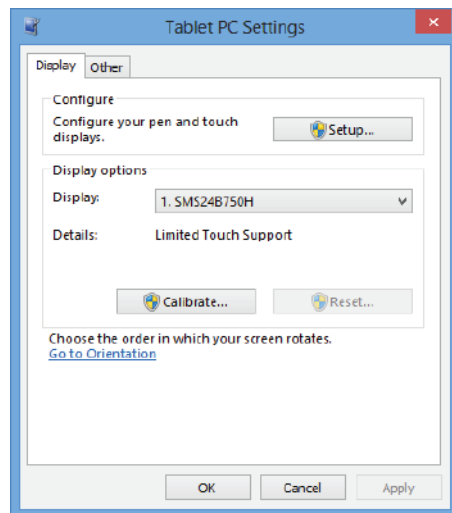

2 Tap the page displayed on the product with your finger.

- ✎ In dual monitor mode: If the following page does not appear on the product, press the Enter key to display the page.



- 3 Select the product from Display under Display options. Next, select Calibrate.

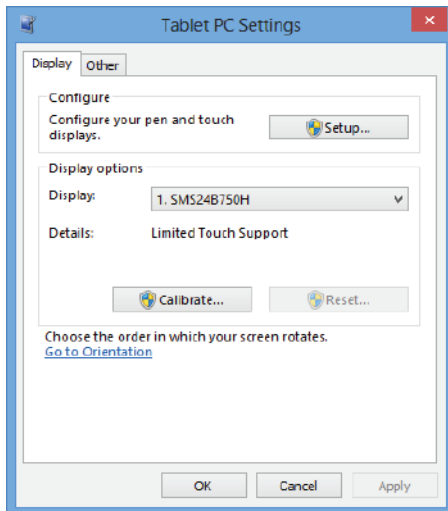

- 4 Perform calibration following the onscreen instructions displayed as shown in the image.

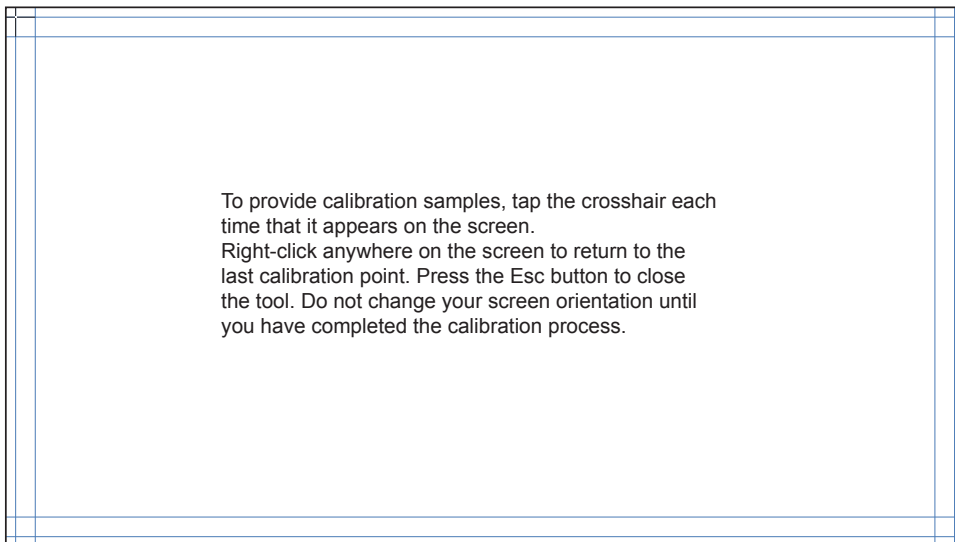

- 5 After calibration is complete, the message Do you want to save the calibration data? appears. Select Yes.

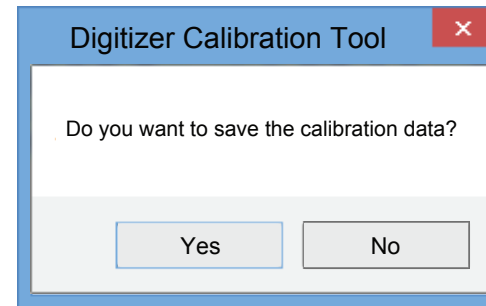

- 6 The touchscreen monitor has been calibrated successfully.  
✎ Selecting Reset will remove the calibration data.

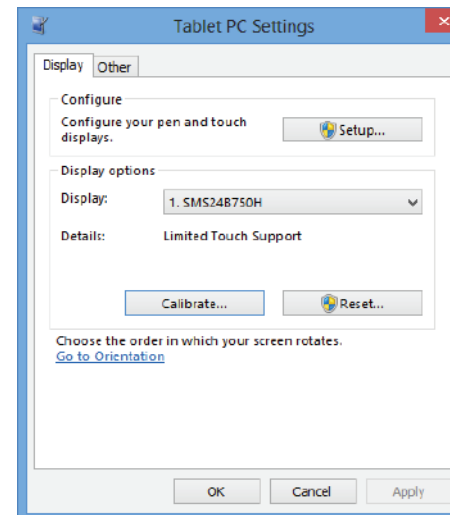

# Chapter 03

## Specifications

### General

Model Name		QM32R / QM32R-A / QM32R-AN / QM32R-B / QM32R-T	QB43R / QB43R-B / QM43R / QM43R-A / QM43R-B / QM43R-T	QB49R / QB49R-B / QM49R / QM49R-B	QB50R / QB50R-B / QM50R / QM50R-A / QM50R-B
Panel	Size	32 CLASS (31.5 inches / 80.1 cm)	43 CLASS (42.5 inches / 107.9 cm)	49 CLASS (48.5 inches / 123.2 cm)	50 CLASS (49.5 inches / 125.7 cm)
	Display area	698.4 mm (H) x 392.85 mm (V)	941.184 mm (H) x 529.416 mm (V)	1073.78 mm (H) x 604.0 mm (V)	1095.84 mm (H) x 616.41 mm (V)

Model Name		QB55R / QB55R-B / QM55R / QM55R-A / QM55R-B / QM55R-T	QB65R / QB65R-B / QM65R / QM65R-A / QM65R-B	QB75R / QB75R-B / QM75R / QM75R-A / QM75R-B
Panel	Size	55 CLASS (54.6 inches / 138.7 cm)	65 CLASS (64.5 inches / 163.9 cm)	75 CLASS (74.5 inches / 189.3 cm)
	Display area	1209.6 mm (H) x 680.4 mm (V)	1428.48 mm (H) x 803.52 mm (V)	1650.24 mm (H) x 928.26 mm (V)

Model Name		QB85R / QB85R-B / QM85R / QM85R-B	QB98R	QE82R
Panel	Size	85 CLASS (84.5 inches / 214.7 cm)	98 CLASS (97.5 inches / 247.7 cm)	82 CLASS (81.5 inches / 207.1 cm)
	Display area	1872.0 mm (H) x 1053.0 mm (V)	2158.848 mm (H) x 1214.352 mm (V)	1805.76 mm (H) x 1015.74 mm (V)



Model Name		QM32R / QM32R-A / QM32R-AN / QM32R-B / QM32R-T	QB43R / QB43R-B / QB49R / QB49R-B / QB50R / QB50R-B / QB55R / QB55R-B / QB65R / QB65R-B / QB75R / QB75R-B / QB85R / QB85R-B / QE82R	QB98R / QM43R / QM43R-T / QM49R / QM50R / QM55R / QM55R-T / QM65R / QM75R / QM85R / QM85R-B	QM43R-A / QM43R-B / QM50R-A / QM50R-B / QM55R-A / QM55R-B / QM65R-A / QM65R-B / QM75R-A / QM75R-B
Resolution	Optimum resolution	3840 x 2160 @ 60 Hz (HDMI)	1920 x 1080 @ 60 Hz (DVI)	1920 x 1080 @ 60 Hz (DVI) 3840 x 2160 @ 60 Hz (HDMI)	3840 x 2160 @ 60 Hz (HDMI)
	Maximum resolution	3840 x 2160 @ 60 Hz (DisplayPort)	3840 x 2160 @ 60 Hz (HDMI)	3840 x 2160 @ 60 Hz (DisplayPort)	3840 x 2160 @ 60 Hz (DisplayPort)
Power Supply		AC100-240V~ 50/60Hz Refer to the label at the back of the product as the standard voltage can vary in different countries.			
Environmental considerations	Operating	Temperature: 0 °C – 40 °C (32 °F – 104 °F) * For installing the enclosure, keep the internal temperature at 40 °C or below. Humidity: 10% – 80%, non-condensing			
	Storage	Temperature: -20 °C – 45 °C (-4 °F – 113 °F) Humidity: 5% – 95%, non-condensing * Applicable before the product package is unpacked.			

- 
- Plug-and-Play  
This monitor can be installed and used with any Plug-and-Play compatible systems. Two-way data exchange between the monitor and PC system optimises the monitor settings. Monitor installation takes place automatically. However, you can customise the installation settings if desired.
  - Due to the nature of the manufacturing of this product, approximately 1 pixel per million (1ppm) may appear brighter or darker on the panel. This does not affect product performance.
  - This product can be set to only one resolution for each screen size to obtain the optimum picture quality due to the nature of the panel. Using a resolution other than the specified resolution may degrade the picture quality. To avoid this, it is recommended that you select the optimum resolution specified for your product.
  - For detailed device specifications, visit the Samsung website.
  - (Europe only)  
To access energy labelling information about this product on the European Product Registry for Energy Labelling (EPREL), go to [https://eprel.ec.europa.eu/qr/\\*\\*\\*\\*\\*](https://eprel.ec.europa.eu/qr/*****) where \*\*\*\*\* is the product's EPREL registration number. You can find the registration number on the rating label of your product.
  - (Turkey only)  
To access the energy labelling information of the model: QB43R ~ QB65R / QB43R-B ~ QB65R-B / QM43R ~ QM65R / QM43R-A ~ QM65R-A / QM43R-B ~ QM65R-B / QM43R-T ~ QM55R-T
    - (1) Go to [https://www.samsung.com/global/ecodesign\\_energy](https://www.samsung.com/global/ecodesign_energy)
    - (2) Get the model identifier from the energy label of the product and type it in the search box
    - (3) Energy labelling information can be found

## Preset Timing Modes

The screen will automatically be adjusted if a signal that belongs to the following standard signal modes is transmitted from your PC. If the signal transmitted from the PC does not belong to the standard signal modes, the screen may be blank with the power indicator on. In such a case, change the settings according to the following table by referring to the graphics card user manual.

 DVI port is not supported on the QM32R, QM32R-T, QMR-A models.

Resolution	Horizontal Frequency (kHz)	Vertical Frequency (Hz)	Pixel Clock (MHz)	Sync Polarity (H/V)	Port		
					DP IN	DVI IN	HDMI IN
IBM, 720 x 400	31.469	70.087	28.322	-/+	0	0	0
MAC, 640 x 480	35.000	66.667	30.240	-/-	0	0	0
MAC, 832 x 624	49.726	74.551	57.284	-/-	0	0	0
MAC, 1152 x 870	68.681	75.062	100.000	-/-	0	0	0
VESA CVT, 3840 x 2160RB	110.500	49.977	442.000	+/-	0	-	-
VESA CVT, 3840 x 2160RB	133.313	59.997	533.250	+/-	0	-	-
VESA DMT, 640 x 480	31.469	59.940	25.175	-/-	0	0	0
VESA DMT, 640 x 480	37.861	72.809	31.500	-/-	0	0	0
VESA DMT, 640 x 480	37.500	75.000	31.500	-/-	0	0	0
VESA DMT, 800 x 600	37.879	60.317	40.000	+/+	0	0	0
VESA DMT, 800 x 600	48.077	72.188	50.000	+/+	0	0	0
VESA DMT, 800 x 600	46.875	75.000	49.500	+/+	0	0	0
VESA DMT, 1024 x 768	48.363	60.004	65.000	-/-	0	0	0
VESA DMT, 1024 x 768	56.476	70.069	75.000	-/-	0	0	0
VESA DMT, 1024 x 768	60.023	75.029	78.750	+/+	0	0	0
VESA DMT, 1152 x 864	67.500	75.000	108.000	+/+	0	0	0
VESA DMT, 1280 x 720	45.000	60.000	74.250	+/+	0	0	0
VESA DMT, 1280 x 800	49.702	59.810	83.500	-/+	0	0	0
VESA DMT, 1280 x 1024	63.981	60.020	108.000	+/+	0	0	0
VESA DMT, 1280 x 1024	79.976	75.025	135.000	+/+	0	0	0
VESA DMT, 1366 x 768	47.712	59.790	85.500	+/+	0	0	0

Resolution	Horizontal Frequency (kHz)	Vertical Frequency (Hz)	Pixel Clock (MHz)	Sync Polarity (H/V)	Port		
					DP IN	DVI IN	HDMI IN
VESA DMT, 1440 x 900	55.935	59.887	106.500	-/+	0	0	0
VESA DMT, 1600 x 900RB	60.000	60.000	108.000	+/+	0	0	0
VESA DMT, 1680 x 1050	65.290	59.954	146.250	-/+	0	0	0
VESA DMT, 1920 x 1080	67.500	60.000	148.500	+/+	0	0	0
VESA DMT, 2560 x 1440RB	88.787	59.951	241.500	+/-	0	-	0
CTA-861, 720(1440) x 576i	15.625	50.000	27.000	-/-	-	0	0
CTA-861, 720(1440) x 480i	15.734	59.940	27.000	-/-	-	0	0
CTA-861, 720 x 576	31.250	50.000	27.000	-/-	0	0	0
CTA-861, 720 x 480	31.469	59.940	27.000	-/-	0	0	0
CTA-861, 1280 x 720	37.500	50.000	74.250	+/+	0	0	0
CTA-861, 1280 x 720	45.000	60.000	74.250	+/+	0	0	0
CTA-861, 1920 x 1080i	28.125	50.000	74.250	+/+	-	0	0
CTA-861, 1920 x 1080i	33.750	60.000	74.250	+/+	-	0	0
CTA-861, 1920 x 1080	27.000	24.000	74.250	+/+	-	0	0
CTA-861, 1920 x 1080	28.125	25.000	74.250	+/+	-	0	0
CTA-861, 1920 x 1080	33.750	30.000	74.250	+/+	-	0	0
CTA-861, 1920 x 1080	56.250	50.000	148.500	+/+	0	0	0
CTA-861, 1920 x 1080	67.500	60.000	148.500	+/+	0	0	0
CTA-861, 3840 x 2160	54.000	24.000	297.000	+/+	-	-	0
CTA-861, 3840 x 2160	56.250	25.000	297.000	+/+	-	-	0
CTA-861, 3840 x 2160	67.500	30.000	297.000	+/+	0	-	0
CTA-861, 3840 x 2160	112.500	50.000	594.000	+/+	0	-	0
CTA-861, 3840 x 2160	135.000	60.000	594.000	+/+	0	-	0
CTA-861, 4096 x 2160	54.000	24.000	297.000	+/+	-	-	0
CTA-861, 4096 x 2160	67.500	30.000	297.000	+/+	-	-	0
CTA-861, 4096 x 2160	112.500	50.000	594.000	+/+	-	-	0
CTA-861, 4096 x 2160	135.000	60.000	594.000	+/+	-	-	0

# Chapter 04

## Appendix

### Licence



Manufactured under license from Dolby Laboratories. Dolby, Dolby Audio, Pro Logic, and the double-D symbol are trademarks of Dolby Laboratories.

---



The terms HDMI and HDMI High-Definition Multimedia Interface, and the HDMI Logo are trademarks or registered trademarks of HDMI Licensing Administrator, Inc. in the United States and other countries.

---

#### Open Source Licence Notice

In the case of using open source software, Open Source Licences are available on the product menu. Open Source Licence Notice is written only English.

For information on the Open Source Licence Notice, contact the Samsung Customer Centre or send email to [oss.request@samsung.com](mailto:oss.request@samsung.com).

---



THIS PRODUCT IS SOLD WITH A LIMITED LICENCE AND IS AUTHORISED TO BE USED ONLY IN CONNECTION WITH HEVC CONTENT THAT MEETS EACH OF THE THREE FOLLOWING QUALIFICATIONS: (1) HEVC CONTENT ONLY FOR PERSONAL USE; (2) HEVC CONTENT THAT IS NOT OFFERED FOR SALE; AND (3) HEVC CONTENT THAT IS CREATED BY THE OWNER OF THE PRODUCT.

THIS PRODUCT MAY NOT BE USED IN CONNECTION WITH HEVC ENCODED CONTENT CREATED BY A THIRD PARTY, WHICH THE USER HAS ORDERED OR PURCHASED FROM A THIRD PARTY, UNLESS THE USER IS SEPARATELY GRANTED RIGHTS TO USE THE PRODUCT WITH SUCH CONTENT BY A LICENSED SELLER OF THE CONTENT.

YOUR USE OF THIS PRODUCT IN CONNECTION WITH HEVC ENCODED CONTENT IS DEEMED ACCEPTANCE OF THE LIMITED AUTHORITY TO USE AS NOTED ABOVE.

---